

McIntosh

STEREO TUNER

MR66

TABLE OF CONTENTS

| | |
|-------------------------------------|----|
| INTRODUCTION | 1 |
| TECHNICAL DESCRIPTION | 1 |
| FRONT PANEL INFORMATION | 3 |
| BACK PANEL INFORMATION | 5 |
| INSTALLATION | 6 |
| CONNECTING | 8 |
| Monophonic FM and AM | 8 |
| Stereophonic FM and AM | 9 |
| Stereophonic FM Multiplex | 9 |
| Remote Amplifiers | 9 |
| Off-The-Air Tape Recording | 9 |
| Antenna Connections | 9 |
| OPERATING INSTRUCTIONS | 11 |
| Monophonic AM Reception | 11 |
| Monophonic FM Reception | 11 |
| Stereophonic FM-AM Reception | 12 |
| Stereophonic FM Multiplex Reception | 12 |
| ADJUSTMENTS | 12 |
| Muting Threshold | 12 |
| AM Signal Strength Indicator | 12 |
| FM Tuning Meter | 13 |
| AM and FM Output Levels | 13 |
| Dial Panel Light | 14 |
| GUARANTEE | 14 |



OWNER'S MANUAL

MR66 STEREOPHONIC TUNER

INTRODUCTION

The McIntosh MR66 is a precision engineered, sensitive AM-FM stereo tuner. It offers the finest possible reception of AM and FM broadcasts. Every desirable feature is included on the MR66. It is perfect for use in a stereo system where nothing less than THE BEST will do.

Once you have used the MR66 and enjoyed its outstanding performance, you will understand why McIntosh products have earned their reputation as THE BEST.

The MR66 is quite flexible in operation. It receives monophonic FM, monophonic AM and stereophonic AM-FM broadcasts. It also receives FM multiplex stereophonic broadcasts with the simple addition of the McIntosh MA6 multiplex adapter. The MR66 front panel control and switch facilities provide for every desirable mode of tuner operation.

Your McIntosh MR66 tuner will give you years of the finest possible AM and FM reception and will become a highly valued part of your home music system.

TECHNICAL DESCRIPTION

FM SECTION

The MR66 FM RF tuning section uses a special cascode amplifier that amplifies the weakest signals and yet maintains low noise and freedom from spurious signals. An additional tuned RF circuit combined with a 4 gang tuning capacitor contributes greatly to the excellent selectivity and high rejection of spurious signals.

A newly developed Automatic Frequency Control (AFC) circuit greatly simplifies tuning. As the tuning knob is moved, the tuner responds as if there were no AFC action. Approximately 3 seconds after the dial has come to rest on a particular station, the AFC circuit gradually comes into operation. The AFC action automatically brings the electrical tuning to the correct point for minimum distortion. This automatic tuning repeats its action each time the tuning dial is moved to a different station. The amount of AFC action is fully adjustable with a front panel control.

The unique AFC circuit uses a variable-capacitance silicon diode in place of a conventional tube to improve the over-all AFC performance. The silicon diode is unaffected by temperature changes, has no warmup drift, and eliminates tube filament hum. A special temperature-compensated narrow-band detector supplies operating signals to the AFC circuit to insure positive action. The narrow-band detector also operates the FM tuning meter amplifier and the ultrasonic interstation muting circuit.

Three flat-topped response IF amplifiers reject adjacent channel interference and provide adequate gain to operate both limiters on even the weakest signals. Two limiters are used to insure the best possible signal-to-noise ratio. Both the RF and IF circuits are completely shielded and exceed the FCC requirements for suppression of FM oscillator and IF frequency radiation.

AM SECTION

The MR66 delivers AM reception of the highest possible quality. Four different AM bandwidth/frequency response settings are available. The NARROW setting provides excellent selectivity and high noise rejection for the weaker and more distant stations. The MEDIUM 1, MEDIUM 2 and BROAD settings provide progressively wider frequency response for receiving the closer more powerful stations.

In all but the BROAD setting a very sharply-tuned whistle filter eliminates the 10KC interference caused by adjacent-channel station carriers. This highly-selective filter reduces the 10KC interference 60db (decibels) below normal program level with no effect on other audio frequencies.

Local AM reception at the BROAD and MEDIUM 2 settings is of unusually high fidelity and limited only by the quality of the actual broadcast signal itself.

A double-tuned circuit at the input of the RF amplifier increases selectivity while retaining the excellent AM bandwidth. The antenna coils are connected with a rear panel switch to allow perfect matching of a convenient short loop antenna or a conventional long lead antenna.

An amplified automatic VOLUME control circuit maintains uniform volume output over a wide range of station signal strengths. Powerful local stations, as well as weak or distant stations, are reproduced at an almost equal volume level. The need for constant volume adjustment during tuning is therefore eliminated.

Two IF amplifiers are coupled through a low-distortion detector into a two-stage feedback amplifier. The output is low-impedance and approximately equal in level to the FM output. Level controls on the rear panel allow you to exactly match the AM and FM output volume levels.

GENERAL

A new type of mechanical tuning assembly gives the MR66 extremely smooth flywheel tuning. The tuning capacitors are driven directly; the tuning capacitors, in turn, drive the dial pointers. Backlash is practically eliminated with this method of design. A teflon-lined pointer carriage and nylon pulleys reduce friction and wear to give an unusually smooth and quiet dial action.

SPECIFICATIONS

FM CHANNEL

Sensitivity

3¼ microvolts at 100% modulation (± 75 KC deviation) for less than 3% total noise and distortion in accordance with IHFM standards.

Distortion

Less than 0.8% at 100% modulation (± 75 KC deviation), above 10 microvolts at antenna terminals.

Audio Frequency Response

Within 2db from 20 to 20,000 cycles.

Capture Ratio

1 to 0.7

Muting

IF injected ultrasonic muting; 60db or more noise reduction between stations.

Oscillator Drift

Less than 25KC with AFC disabled; negligible

with AFC in operation.

Image Rejection

Better than 80db at 90MC; better than 70db at 105MC.

Hum

Better than 65db below 100% modulation.

IF Amplifiers

Three (not including two limiters) with 200KC bandwidth, flat-top response.

RF Amplifier

Cascode

Radiation

Substantially below FCC requirements.

Antenna Inputs

300 ohms balanced; 75 ohms unbalanced.

Output

Approximately 4 volts, low impedance.

AM CHANNEL

Sensitivity

1.5 microvolts.

Selectivity

Narrow; 4KC bandwidth, ± 10 KC from center down 53db.

Medium 1; 13KC bandwidth, ± 10 KC from center down 20db.

Medium 2; 23KC bandwidth, ± 10 KC from center down 1.5db.

Broad; 23KC bandwidth, ± 10 KC from center down 1.5db.

These characteristics are substantially unchanged over entire RF tuning range.

Distortion

Less than 1½% at 100% modulation.

Hum

50db below full signal.

Audio Bandwidth

Narrow; within 3db, 20 to 2,000 cycles.

Medium 1; within 3db, 20 to 6,500 cycles.

Medium 2; within 3db, 20 to 8,000 cycles.

Broad; within 3db, 20 to 11,500 cycles.

10KC Whistle Filter

70db rejection at 10KC; none on Broad setting.

Output

Approximately 4 volts, low impedance,

Power Consumption

75 watts, 105 to 125 volts, 50 to 60 cycles, (entire tuner).

Tube Complement (18)

| | |
|----------|--|
| 6BA6 | AM RF Amplifier |
| 6BE6 | AM Converter |
| 6BA6 | 1st AM IF Amplifier |
| 6BY8 | 2nd AM IF Amplifier |
| 6BY8 | AGC Amplifier |
| 6U8 | AM Audio Preamplifier |
| 6BN4A | FM RF Amplifier |
| 6BN4A | FM Oscillator |
| 12AT7 | FM Mixer |
| (3) 6AU6 | FM IF Amplifiers |
| 6BN8 | FM Ultrasonic Muting |
| 6AU6 | 1st FM Limiter |
| 6CS6 | 2nd FM Limiter |
| 12AU7 | FM Meter and AGC Clamp |
| 6U8 | FM Audio Preamplifier |
| 6BW4 | High Voltage Rectifier (10mmu to both channels) |

Dimensions

Front Panel: 15⁵/₈ inches by 5¹/₈ inches.

Overall depth of chassis behind front panel: 12³/₁₆ inches.

Depth from face of knobs to face of mounting panel: 1¼ inches.

Weight

Chassis-only, 27 pounds; in shipping carton, 32 pounds.

FRONT PANEL INFORMATION

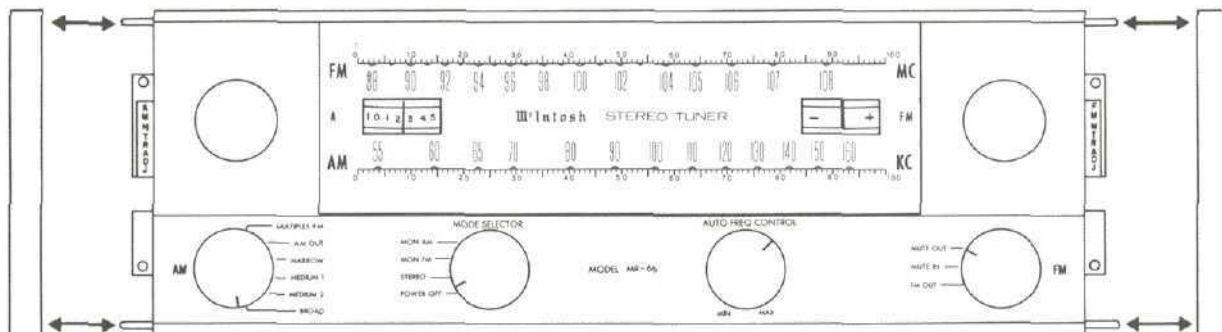

Figure 1. MR66 Front Panel.

TUNING DIALS

The MR66 includes AM and FM tuning dials on the front panel. The AM tuning knob is at the left and the FM tuning knob is at the right. The AM tuning dial is calibrated in kilocycles and the FM tuning dial is calibrated

in megacycles. Each tuning dial also includes a 0-100 logging scale. Tuning back to a particular station is much easier by keeping a record of the exact station location on the logging scale.

TUNING METERS

Two tuning meters are included in the dial panel. At the left is the AM SIGNAL STRENGTH tuning meter. At the right is the FM TUNING meter.

An AM station is correctly tuned when the AM signal strength meter pointer indicates maximum right-hand deflection. The actual amount of meter pointer deflection indicates the relative signal strength of each particular station. Strong local stations will cause almost full meter deflection. Weaker or more distant stations may cause only a slight meter deflection.

An FM station is correctly tuned when the pointer of the FM tuning meter comes to rest anywhere in the small black center area of the meter scale.

The zero settings of both meters can be adjusted if necessary. See the section titled "ADJUSTMENTS."

AM FUNCTION SWITCH

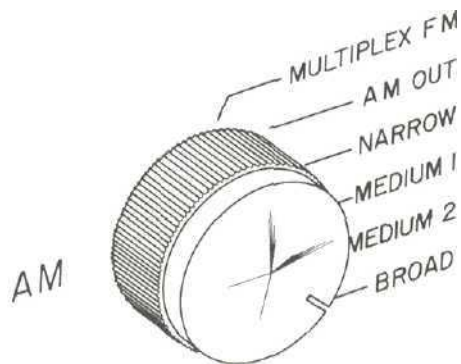

Figure 2. AM Function Switch.

Multiplex FM

Provides multiplex FM stereo reception with the simple addition of a McIntosh MA6 multiplex FM adapter.

AM Out

Turns off the AM section of the MR66.

Narrow

Sharpest and most selective AM tuning for receiving distant or weak stations with minimum noise and interference from other stations.

Medium 1 and Medium 2

Progressively wider frequency response for closer or more powerful local stations.

Broad

Widest possible AM frequency response for high-fidelity reception of powerful local stations. The 10KC whistle filter is not operative at this switch setting.

MODE SELECTOR SWITCH

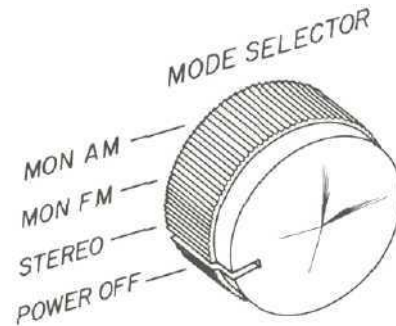

Figure 3. Mode Selector Switch.

Power Off

Turns off the MR66 AC power. The AC outlet on the back panel also turns off with this switch. If a TV antenna is used for FM in the manner described under "ANTENNA CONNECTIONS," it will automatically be switched back to the TV set in the POWER OFF position.

Stereo

Turns the MR66 AC power ON and provides simultaneous AM and FM signals at the back panel jacks marked STEREO-MON 1 and 2, respectively.

MON FM

Provides monophonic FM signals at "both" the STEREO-MON 1 and 2 back panel jacks.

MON AM

Provides monophonic AM signals at "both" the STEREO-MON 1 and 2 back panel jacks.

Note:

AM signals are always present at the back panel AM jack, and FM signals are always present at the FM jack, regardless of the MODE SELECTOR switch settings.

AUTO FREQ CONTROL

The automatic frequency control (AFC) circuit makes FM tuning easier and elimi-



Figure 4. Auto Freq Control.

notes the possibility of the tuner drifting off the station. The AFC circuit in the MR66 includes an Electronic Delay which is an exclusive McIntosh development. As the tuning dial is moved, the AFC circuit is temporarily cut off. Approximately three seconds after the dial pointer has come to rest on a particular station, the AFC action gradually comes into operation. The AFC automatically brings the electrical tuning to the correct point for minimum distortion. This automatic tuning repeats itself each time the FM dial is moved to a different station.

The degree of AFC action is adjustable with the AUTO FREQ CONTROL. Full left (MIN) position of the control cuts off AFC action. Full right (MAX) position gives maximum AFC action.

Normally, the best tuning occurs with the AUTO FREQ CONTROL set at or near MAX position. If several stations are very close together on the dial or if a desired station is

close to a much stronger station, a lower AFC setting is usually necessary for best tuning.

FM FUNCTION SWITCH

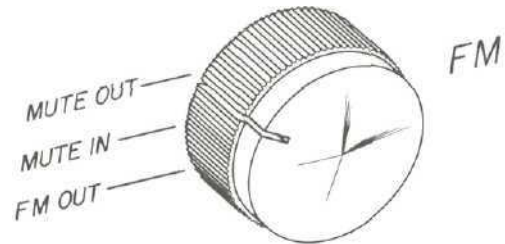

Figure 5. FM Function Switch.

FM Out

Turns off the FM section of the MR66.

Mute In

Turns on FM with the McIntosh developed ultrasonic mute-in operation. Ultrasonic muting suppresses all noise between stations including noises heard tuning in and out of a station. Weak or distant stations mixed with noise or interference are also suppressed.

Mute Out

Turns off the ultrasonic muting to allow conventional FM tuning with inter-station noise present. Use this setting to listen to weak or distant stations that may be mixed with noise or interference.

BACK PANEL INFORMATION

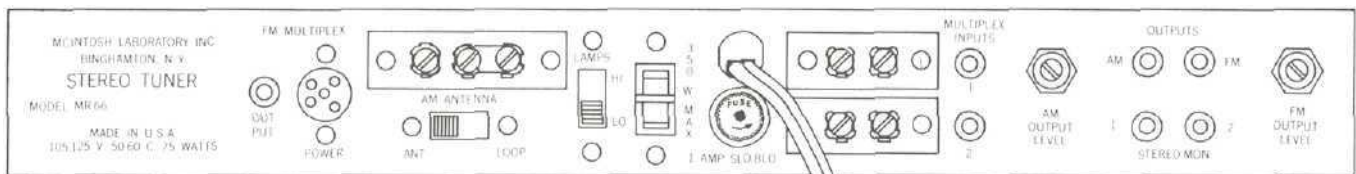

Figure 6- MR66 Back Panel.

FM MULTIPLEX OUTPUT

Connects to the input lead of the McIntosh MA6 FM multiplex adapter.

FM MULTIPLEX POWER

Connects to the McIntosh MA6 FM multiplex adapter power plug. Correct operating voltages are supplied for the MA6 (6.3 volts AC at 1 amp and 120 volts DC at 25 ma.)

MULTIPLEX INPUTS

Connect to the McIntosh MA6 FM multiplex adapter output leads.

AM ANTENNA

Terminals for connecting the AM antenna to the MR66.

ANT LOOP SWITCH

Adjusts the MR66 circuit to match the particular type of AM antenna used. ANT position is for a conventional antenna, usually of the outdoor type, from 50 to 150 feet in length. LOOP position is for the short loop antenna supplied with the MR66.

LAMPS SWITCH

Provides bright (HI) or dim (LO) front panel lighting.

AC OUTLET

Provides 117 volt AC power up to 350 watts maximum for additional equipment such as turntables or other tuners. This outlet is not fused and turns on and off with the front panel MODE SELECTOR switch.

FUSE

1 amp Slo-Blo type fuse to protect the tuner circuit. This fuse does not operate on the AC outlet.

FM ANT

Terminals for connecting an FM antenna to the MR66.

TO TV SET

Terminals for connecting TV set antenna leads when a VHF TV antenna is used for both the MR66 and the TV set. The antenna is automatically switched to the MR66 when

the MODE SELECTOR turns the MR66 ON. The antenna is switched back to the TV set when the MODE SELECTOR is turned to POWER OFF.

STEREO-MON OUTPUTS

1 and 2 output jacks supply tuner signals of the correct value to connect to tuner inputs or auxiliary inputs of a control preamplifier. The front panel MODE SELECTOR switch provides stereo AM-FM at jacks 1 and 2, respectively; monophonic FM at "both" jacks 1 and 2; or monophonic AM at "both" jacks 1 and 2.

AM FM OUTPUTS

AM signals are present at the AM jack and FM signals are present at the FM jack at all times the tuner is operating, regardless of the MODE SELECTOR switch setting. The AM function switch and the FM function switch affect the signals at these output jacks. Use these jacks to connect the tuner to remote amplifiers, apart from the main sound system.

AM OUTPUT LEVEL CONTROL

Adjusts the volume level of the AM output. See section titled "ADJUSTMENTS."

FM OUTPUT LEVEL CONTROL

Adjusts the volume level of the FM output. See section titled "ADJUSTMENTS."

INSTALLATION

The McIntosh MR66 tuner may be installed on a table, on a shelf, in a custom built-in cabinet or in a professional equipment rack. For best appearance in an open installation, it is suggested that you mount the MR66 in the attractive McIntosh Model L66 finished wood cabinet.

The MR66 may be mounted in panels up to 1 inch in thickness. If the panel is at least ¼ inch in thickness, the tuner will be adequately supported by the four front panel mounting screws. In cases where the front panel may be thin or flexible, a shelf is necessary to support the weight of the tuner. A shelf is not required when the MR66 is mounted in a metal rack panel.

An MR66 cabinet installation should provide at least 13% inches behind the mounting panel for clearance of leads and connectors. Allow inside dimensions of at least 16½ inches in width and 5 inches in height for adequate air circulation. The back panel of the MR66 cabinet should be left as open as possible for best ventilation. Avoid mounting the tuner directly over a power amplifier. The heat from the amplifier output tubes may affect the precision tuner calibration. Adequate ventilation will insure your tuner a long and trouble-free life.

CUTTING THE FRONT PANEL

The PANEL CUTOUT TEMPLATE supplied with your tuner is a full size layout of the front panel cutout and mounting holes. The template is positioned accurately on the cabinet front panel by drilling two locating holes through from the backside of the panel. All measurements for panel cutout location are made on the backside of the panel. One of the two end mounting strips supplied with the tuner (3½ inches by ½ inch) makes a convenient measuring tool for determining the exact positions of the locating holes.

Determine the exact center of the proposed panel cutout area. Scribe a vertical line at the center, from the top surface of the mounting shelf to the top of the panel as shown in "A" of Figure 7. Using one of the mounting strips as a measuring tool, scribe a horizontal line 3½ inches above the top surface of the mounting shelf as shown in "B" of Figure 7. Again using the mounting strip, mark a point on the horizontal line 3½ inches to the left of the center line. Mark a second point 3½ inches to the right of the center line. These two points should be 7 inches apart, 3½ inches above the mounting shelf and 3½ inches to each side of the vertical center line. See "C" of Figure 7. Drill a $\frac{3}{16}$ inch diameter hole through the back of the panel at each of the two points. Make certain that you hold the drill perpendicular to the panel so the holes will be accurately located on the front side of the panel.

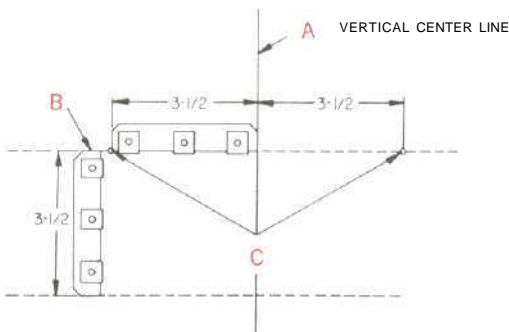

Positions "A" to "C" show the location of the vertical center line, the use of the measuring tool (mounting strip) to locate the horizontal center line, and how to measure off the two points to the right and left of the vertical center line.

Figure 7. Front Panel Cutout Measurements.

Using the previously drilled locating holes for correct alignment, carefully position the cutout template on the front panel.

Scribe the rectangular cutout on the front panel and mark the positions of the six mounting holes. Drill the six $\frac{3}{16}$ inch diameter mounting holes before cutting the panel opening. Next cut the main panel opening. It is important that the cutout be just within the heavy black lines on the template.

SHELF MOUNTING

Locate the exact center of the proposed shelf area and scribe a line from the front to the back of the shelf. The SHELF CUTOUT TEMPLATE is marked for front panel thickness from ¼ inch to 1 inch. Fold the template on the line that corresponds to the thickness of the particular panel being used. Place the folded template on the shelf, butted against the backside of the front panel. Match the center line on the template to the scribed center line on the shelf. The shelf center line should also exactly meet the vertical center line used to make the front panel cutout. Mark the positions of the four ¼ inch diameter mounting holes. Scribe the rectangular cutout for the ventilating hole. Drill the four ¼ inch diameter mounting holes and cut out the rectangular ventilating hole.

INSTALLING THE MR66

Remove the four 10-32 x ¾ inch screws holding the MR66 to the shipping board. Save these screws since you will need them if your cabinet shelf is ½ inch or $\frac{5}{8}$ inch thick. Remove the four plastic feet from the bottom of the tuner.

The mounting hardware package includes four 6-32 flat head screws and eight 6-32 round head screws. Two of the flat head screws of the proper length are used to attach the mounting strips to the cabinet panel. Four of the round head screws of the proper length are used to attach the tuner to the mounting strips and the cabinet panel. The 6-32 x ½ inch screws are used with panels under $\frac{3}{8}$ inch thickness. The 6-32 x 1¼ inch screws are used with panels from $\frac{3}{8}$ inch to 1 inch thickness.

The edge of the strip with the clips must face toward the panel opening. Line up the mounting strips on each side of the panel cutout so the holes in the strips are in line with the holes in the panel. (See Figure 8.) Install the proper length flat head screws through the front panel and into the center hole of each strip. Drive the screws in so the flat heads are flush with the panel. If necessary, countersink the two center holes.

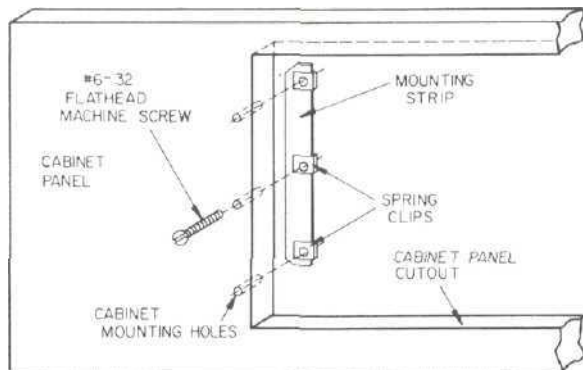

Figure 8. Securing The Mounting Strip To The Front Panel.

Carefully insert the tuner through the front panel opening so it rests on the supporting shelf. Insert the proper length round head screws into the four holes in the mounting flanges on each end of the tuner panel. Drive the screws in through the panel and into the threaded clips on the mounting strips. Do not tighten these screws yet.

If the cabinet is fixed and will not be moved about, it is not necessary to secure the tuner chassis to the shelf. If the cabinet is to be moved about, it is recommended that the tuner chassis be secured to the shelf in the following manner.

Tighten the four screws holding the tuner to the front panel. The four 10-32 x $\frac{3}{4}$ inch screws used in shipping the tuner are also used to mount it to a shelf of $\frac{1}{2}$ inch or $\frac{5}{8}$ inch thickness. Use the 10-32 x $\frac{1}{2}$ inch screws if the mounting shelf is $\frac{3}{8}$ inch thick-

ness or less. Use the 10-32 x 1 inch screws if the shelf is $\frac{3}{4}$ inch or $\frac{7}{8}$ inch thickness. Secure the chassis with the proper length 10-32 screws by inserting them up through the holes in the shelf and into the threaded holes in the tuner chassis bottom. Tighten the 10-32 screws after you have first tightened the front panel screws.

IMPORTANT

Use of the wrong length 10-32 screws may cause electrical shorting in the tuner circuits.

Attach the two metal panel end caps (packed with the tuner) on each end of the tuner panel by sliding onto the pins. (See Figure 9.) The end caps are held by spring tension and can easily be removed if the tuner is to be taken out of the cabinet.

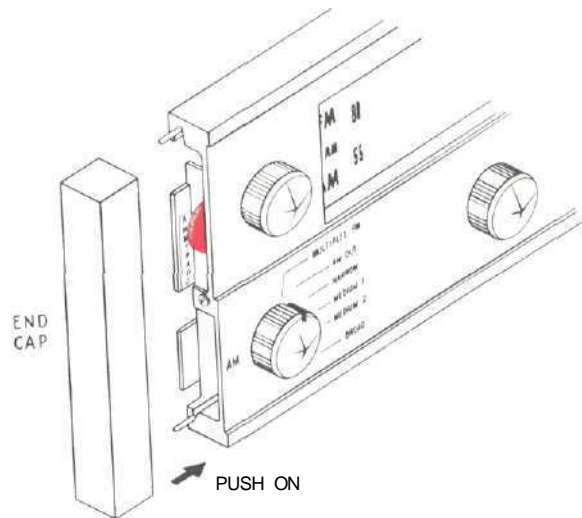

Figure 9. Fitting End Caps To Tuner Panel.

MOUNTING IN THE L66 CABINET

The McIntosh L66 cabinet is supplied with complete instructions and all necessary hardware for installing the MR66 tuner. The dimensions of the L66 cabinet are $16\frac{9}{16}$ inches wide by $6\frac{11}{16}$ inches high including mounting feet by $13\frac{3}{4}$ inches deep including tuner front panel and control knobs.

CONNECTING

MONOPHONIC FM AND AM

Connect one end of a shielded cable supplied with the tuner to either the STEREO-MON 1 or 2 output jack on the back panel of

the MR66. Connect the other end of the cable to a high-level auxiliary or tuner input of a monophonic preamplifier. The MR66 has sufficient output level to be connected

directly to a power amplifier if desired. Since the MR66 does not include a front panel volume control, all volume adjustments must be made at the preamplifier. The MR66 rear panel output level controls provide means for setting and balancing the volume levels of the AM and FM outputs.

AM monophonic and FM monophonic programs appear at both STEREO MON 1 and 2 jacks, depending on whether the MODE SELECTOR switch is set to MON AM or MON FM.

STEREOPHONIC FM AND AM

Connect one end of a shielded cable supplied with the MR66 to the STEREO MON 1 output jack on the back panel of the MR66. Connect the other end of this cable to the left-channel high-level auxiliary or tuner input of a stereophonic control preamplifier. Connect one end of another shielded cable from the STEREO MON 2 output jack to the right-channel high-level auxiliary or tuner input of the stereophonic control preamplifier. Two separate monophonic preamplifiers may also be used for the separate channels in a similar manner. (Channels 1 and 2 refer to left and right respectively.)

AM-FM stereophonic programs will be heard with the AM through the left channel and the FM through the right channel. Monophonic AM and monophonic FM programs will also be heard with these connections depending on the MR66 MODE SELECTOR switch setting. Monophonic programs will appear through both channels simultaneously.

STEREOPHONIC FM MULTIPLEX

For reception of FM Multiplex Stereo, connect the MR66 tuner the same as for stereophonic FM-AM. Then connect the McIntosh MA6 Multiplex Adapter to the MR66 as follows.

Connect the MA6 Multiplex Adapter power plug to the FM multiplex power socket on the MR66 back panel. Connect a 24-inch shielded cable supplied with the MA6 adapter from the adapter INPUT jack to the FM MULTIPLEX OUTPUT jack on the MR66 back panel. Connect a 24-inch shielded cable from the LEFT OUTPUT jack on the MA6 adapter to the MULTIPLEX INPUT 1 on the MR66 back

panel. Connect a 24-inch shielded cable from the RIGHT OUTPUT jack on the MA6 adapter to the MULTIPLEX INPUT 2 on the MR66 rear panel. The numbers 1 and 2 on the MR66 back panel refer to left and right channels respectively.

REMOTE AMPLIFIERS

The AM and FM OUTPUT jacks on the MR66 back panel provide separate AM and FM signals at all times, regardless of the MR66 MODE SELECTOR switch setting. These jacks may be connected to external power amplifiers for purposes of feeding AM and FM programs to other speaker locations apart from the main sound system.

OFF-THE-AIR TAPE RECORDING

Tape recorders or tape decks with record-playback preamplifiers are normally connected to the Tape Output jacks on the control preamplifier. Any FM or AM program coming from the tuner into the preamplifier can then be recorded on tape. You may also connect the AM and FM or STEREO-MON jacks directly to the recorder inputs if desired.

AM ANTENNAS

INDOOR LOOP

For most local and moderately distant AM reception the convenient loop antenna wire supplied with the MR66 may be used. Remove the metal link between the AM ANTENNA terminals marked LO and GND on the MR66 back panel. Connect one end of the loop to the HI terminal. Connect the other end of the loop to the LO terminal. Set the AM ANTENNA slide switch on the MR66 back panel to the LOOP position. (See Figure 11.)

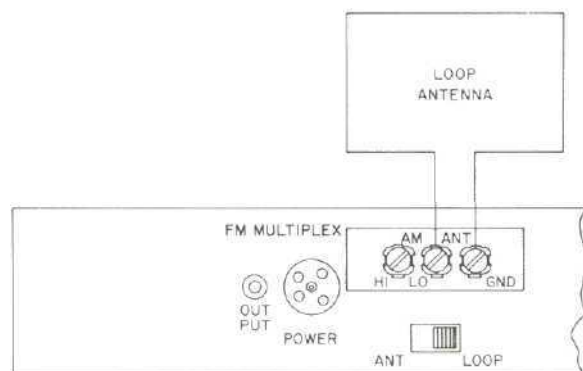

Figure 11. Indoor Loop Antenna Connections.

The AM loop may be conveniently tacked behind the stereo equipment cabinet, or stretched along the floor or baseboard. The loop should be spaced as wide apart as possible.

AM OUTDOOR ANTENNA

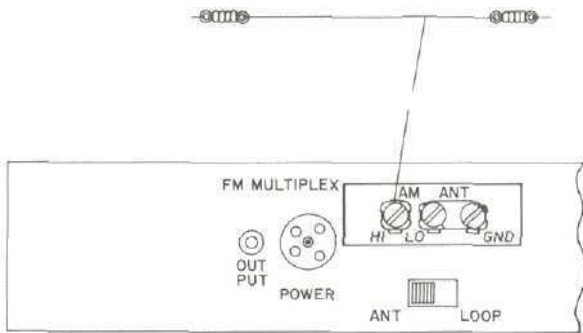

Figure 12. AM Outdoor Antenna.

For best long distance AM reception, use a copper antenna wire 50 to 150 feet in length. Suspend the wire in a straight line as high as possible. Attach the wire at each end with suitable glass or ceramic insulators. Connect a lead-in wire at any convenient point on the antenna. (See Figure 12.) It is recommended that a lightning arrester be used with an outdoor AM antenna. The arrester should be well grounded to a suitable water pipe or copper or aluminum rod sunk into the ground.

Connect the lead-in wire to the HI terminal on the AM ANTENNA terminal strip on the MR66 back panel. Leave the metal link in place between the LO and GND terminals. Set the AM ANTENNA Slide Switch on the MR66 back panel to the ANT position.

INDOOR FLEXIBLE FM DIPOLE

The convenient flexible indoor dipole (300 ohm) antenna is supplied with the MR66 tuner. This antenna is suitable for FM reception in urban or high-intensity signal areas.

Connect the two leads of the dipole antenna to the two terminals marked FM ANT on the MR66 back panel. (See Figure 12.) The flexibility of the thin flat wire allows the dipole to be easily located behind the equipment enclosure or in any convenient position near the tuner. Open the dipole into a "T" and extend the arms as straight as possible. The dipole antenna is somewhat directional

300 OHM INDOOR
DIPOLE FM ANTENNA

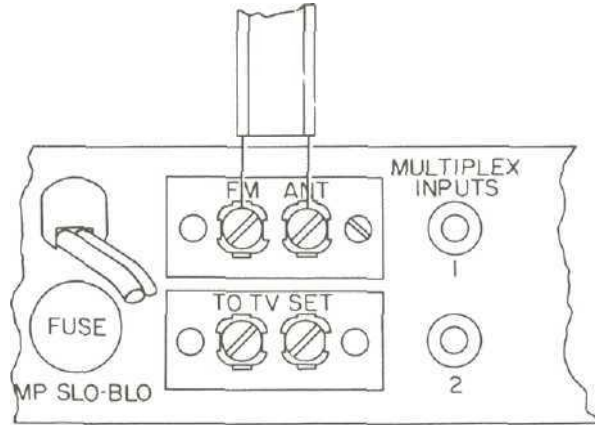

Figure 13. Connection For 300 Ohm Indoor Dipole FM Antenna.

and may have to be positioned in a particular location for best reception of the desired stations. The dipole may be carefully tacked or taped into position.

IMPORTANT

Keep the dipole away from large metal objects or surfaces since they may interfere with the efficiency of the antenna.

FM OUTDOOR ANTENNA

An outdoor FM antenna is always recommended for best FM reception under all conditions. In fringe or outlying areas, a highly directional FM antenna used in conjunction with a rotator will give the finest possible FM reception. Rotate the antenna until it points toward the station or receives the best possible signal.

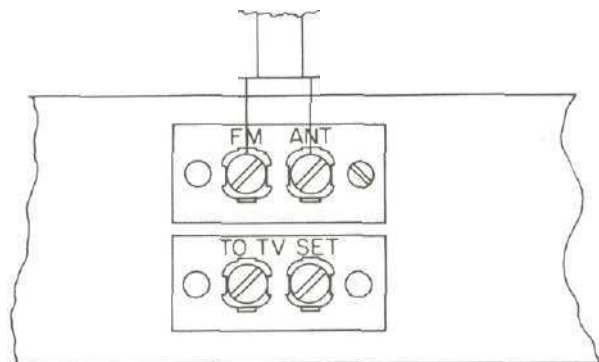

Figure 14. Connection For 300 Ohm Outdoor FM Antenna.

Connect the two wires of the 300 ohm lead-in from the external antenna to the MR66 back panel FM ANT terminals.

75 OHM ANTENNA

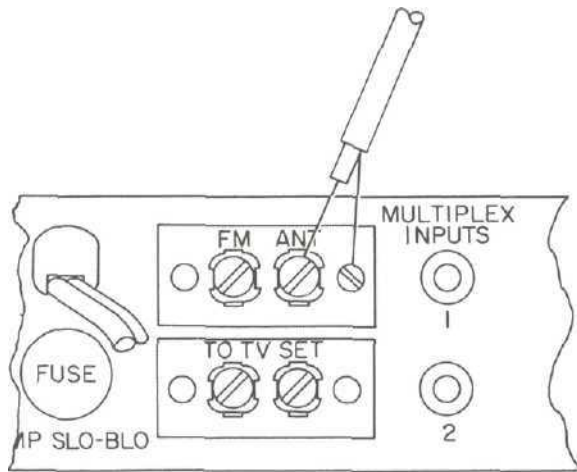

Figure 15. Connection For 75 Ohm Coaxial Antenna.

An unbalanced 75 ohm FM antenna may also be used with the MR66. Connect the center lead of the coaxial lead-in cable to the right hand FM ANT terminal. Connect the shield of the coaxial cable to the ground screw next to the right of this same FM ANT terminal.

VHF-TV ANTENNA

A conventional VHF TV antenna of the type also suitable for FM may be used with the MR66. Connect the two leads from the 300 ohm TV antenna lead-in wire to the two FM ANT terminals on the MR66 back panel.

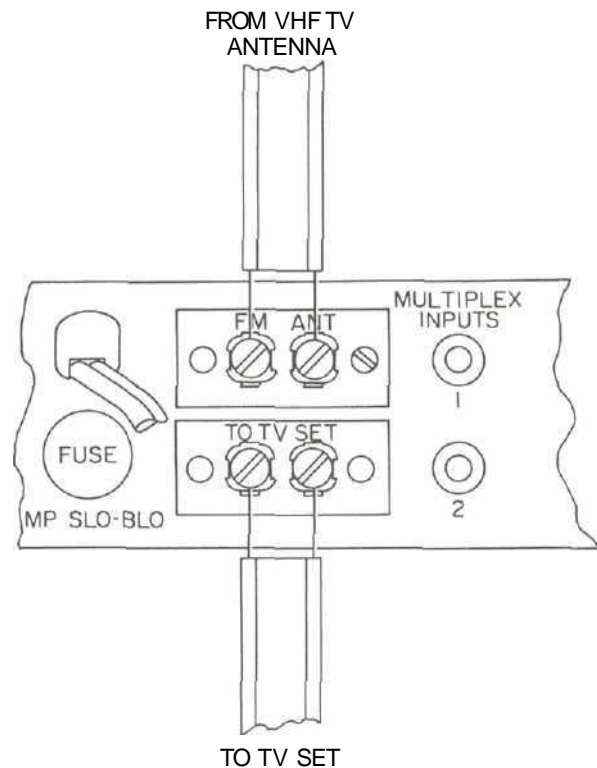

Figure 16. VHF TV Antenna Connections.

Connect a length of 300 ohm flat lead-in wire from the TO TV SET terminals on the MR66 back panel to the antenna terminals of the TV set.

The MR66 MODE SELECTOR switch automatically switches the VHF TV antenna to the MR66 in any of the "on" positions. The antenna is switched back to the TV set in the POWER OFF position.

OPERATING INSTRUCTIONS

MONOPHONIC AM RECEPTION

Turn the MR66 MODE SELECTOR switch to MON AM. Turn the FM FUNCTION switch to FM OUT. Turn the AM FUNCTION switch to any of the four bandwidth settings. It is usually easiest to tune at the NARROW or MEDIUM 1 position. After a warm up time of approximately 30 seconds, turn the AM tuning dial to the desired station. Depending on the quality of the AM signal, select the best possible bandwidth setting. (See the section titled "AM FUNCTION SWITCH.": The AM Signal Strength meter will indicate the relative strength of the particular AM station being received.

MONOPHONIC FM RECEPTION

Turn the MODE SELECTOR switch to MON FM. Turn the AM FUNCTION switch to AM OUT. Turn the FM FUNCTION switch to MUTE IN. Set the AUTO FREQ CONTROL to any position between MIN and MAX. (See the section titled "AUTO FREQ CONTROL.") After a warmup time of approximately 30 seconds, turn the FM tuning dial to the desired station. The correct FM tuning point is reached when the FM TUNING meter pointer comes to rest anywhere in the center black area of the meter scale. While tuning across the dial you may notice movement of the tuning meter, yet don't hear a station. This is

caused by a station so weak or distant that it does not over-ride the background noise. With ultrasonic muting in operation a noisy station of this type is automatically rejected. To hear these weaker or distant stations, turn the FM FUNCTION switch to MUTE OUT. Usually the listening quality of a station of this type will be rather poor due to the weak signal and background noise. (See section titled "MUTING ADJUSTMENTS.")

If two FM stations are very close together on the dial, the AFC action may tend to capture and hold the stronger of the two stations. Turn the AUTO FREQ CONTROL to the left (counterclockwise) to reduce AFC in order to tune in the weaker station. The quality of the FM program is unaffected by the setting of the AUTO FREQ CONTROL. (See section titled "AUTO FREQ CONTROL.")

STEREOPHONIC AM-FM RECEPTION

Turn the AM FUNCTION switch to BROAD, the MODE SELECTOR switch to STEREO, and the FM FUNCTION switch to MUTE IN. Set the AUTO FREQ CONTROL to any setting between MIN and MAX. Allow a warmup time of approximately 30 seconds.

Tune the AM dial to the AM station broadcasting one channel of the stereophonic program. Then tune the FM dial to the FM

station broadcasting the other channel of the same stereophonic program.

If 10KC squeal interference is present in the AM channel, turn the AM FUNCTION switch to the MED 2 position. This places the 10KC filter in operation.

STEREOPHONIC FM MULTIPLEX RECEPTION

The McIntosh MA6 FM Multiplex Adapter must be properly installed in the MR66 in order to receive FM Multiplex Stereophonic programs. (See Section under "CONNECTING" titled "STEREOPHONIC FM MULTIPLEX.")

Turn the AM FUNCTION switch to MULTIPLEX FM, the MODE SELECTOR switch to STEREO and the FM FUNCTION switch to MUTE IN. Set the AUTO FREQ CONTROL to any position between MIN and MAX. Tune the FM dial to the station broadcasting FM Multiplex Stereo. Satisfactory FM Multiplex Stereo reception requires approximately 10 times as much signal from the antenna compared to equivalent FM monophonic reception. Monophonic installations that were satisfactory with an indoor FM antenna may require an outside or directional FM antenna for equivalent FM Multiplex reception.

ADJUSTMENTS

MUTING THRESHOLD

The MR66 ultrasonic muting circuit suppresses all noise between stations. It also suppresses all weaker stations not strong enough to over-ride the background noise.

The muting threshold setting determines the strength of the signal which can be heard with muting in operation. The muting threshold is carefully adjusted to optimum at the factory using precision test instruments. Casual adjustment of the muting threshold is not recommended.

If it is found necessary to adjust the muting threshold, use the SQUELCH ADJ control on top of the MR66 chassis. Turn the SQUELCH ADJ control to the RIGHT (clockwise) to lower the muting threshold. This allows weaker, noisier stations to be heard at

the MUTE IN setting. Turn the SQUELCH ADJ control to the LEFT (counterclockwise) to raise the muting threshold. This allows only the more powerful stations to be heard at the MUTE IN setting.

AM SIGNAL STRENGTH INDICATOR

The AM Signal Strength indicator pointer normally should rest on the zero scale marking with AM operating but no station tuned in.

To adjust, turn the AM FUNCTION switch to BROAD and the MODE SELECTOR switch to MON AM. Turn the AM tuning dial until the pointer is not on or near a station. Remove the AM antenna from the back panel antenna terminals. (This eliminates any noise or interference which may cause a slight meter deflection.) Rotate the red AM MTR ADJ thumb wheel control (under the left dial

panel end cap) until the meter pointer is centered on the zero scale marking.(Tuner Serial Nos. 1N001 to 1N961 have recessed screwdriver-adjust AM meter control near back of tuner chassis.)

In areas where noise or interference is high, the meter may move above the zero position when the AM antenna is reconnected to the back panel terminals. This is normal and does not affect the meter operation.

FM TUNING METER

Turn the FM FUNCTION switch to FM OUT position. (The meter pilot lamp turns off but the circuit is still on.) All other controls and switches may be in any position. Allow the tuner to operate for approximately 5 minutes. The FM tuning meter pointer should rest in the center of the black scale.

To adjust, rotate the red FM MTR ADJ thumb wheel control (under right dial panel end cap) until the meter pointer rests in the center of the black scale. (Tuner Serial

Nos. 1N001 to 1N961 have a screwdriver-adjust FM meter control near back of tuner chassis.)

AM AND FM OUTPUT LEVELS

Adjust each control until the MR66 AM and FM output volume levels are equal to each other. They should also be equal to the volume levels of other signal sources (such as phono) connected to the control pre-amplifier. You can now switch the pre-amplifier from the MR66 to other program sources without need for readjusting the main preamplifier volume control.

DIAL PANEL LIGHTS

Adjust the brightness of the dial panel lights by means of the lamp slide switch on the MR66 back panel. Set the switch to HI position for maximum dial light. Set the switch to LO for a dimmer light and extended lamp life.

Your McIntosh MR66 tuner will give you many years of pleasant and satisfactory performance. If you have any questions concerning the operation or maintenance of this tuner, please contact

CUSTOMER SERVICE
McINTOSH LABORATORY INC.
2 CHAMBERS STREET
BINGHAMTON, NEW YORK

Our telephone number is 723-5491.
The direct dial area code is 607.

GUARANTEE

McIntosh Laboratory, Inc. guarantees this equipment to perform as advertised. We also guarantee the mechanical and electrical workmanship and components of this equipment to be free of defects for a period of 90 days from date of purchase. This guarantee does not extend to components damaged by improper use nor does it extend to damage incurred during transportation to and from McIntosh Laboratory, Inc.

In Canada: Manufactured under license by:
McCurdy Radio Industries, Ltd.
22 Front Street West
Toronto, Canada

McIntosh LABORATORY INC.

2 CHAMBERS STREET, BINGHAMTON, N. Y.

Made in U.S.A.

Phone —Area Code 607-723-5491